

GENERAL FEATURES



- Ultrasonic working principle
- 0.4 - 9 meters measuring range which can be calibrated from the menu
- Non-contact and high precision measurement
- ± 0.2 FS accuracy
- Single line 5 digit LCD display and 4 sealed keypads for configuration
- Display of measured value in level, distance (cm, m, inch or feet) or volume (liters, m³, imp, gallons)
- RS-232, RS-485 and CANopen serial connection options
- 4-20 mA, 0-20 mA or 0-10V analog output options
- 2 PNP Open Collector outputs
- IP67 high protection class
- Economical and maintenance-free design
- Easy installation

The ultrasonic sensor sends and detects high-frequency ultrasonic sound with a piezoelectric transducer. A part of the reflected sound wave by hitting the measuring surface is detected by the transducer, depending on the speed of the signal in the air, the distance of the objects is determined. When the specified switching point is reached, the output is switched. The measured value is given as analog (0 ... 10 V / 4 ... 20 mA) or CANopen signal.

With ultrasonic sensors, objects can be reliably detected and measured regardless of material, color, transparency and surface properties.

ULS series ultrasonic sensors;

Used in non-contact, level and volume measurement of liquid and solid materials in open and closed tanks. There is also an open canal flow measurement option. It can display the measured value as level, distance (cm, m, inch or feet) or volume (liters, m³, imp, gallons) with 4 sealed membrane keypads.

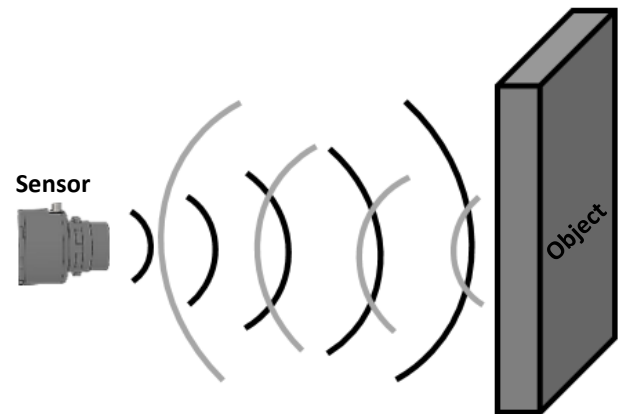

APPLICATION AREAS

- Level measurement, pump control in tank, warehouse etc.
- Occupancy rate calculation in product warehouses
- Treatment plants
- Food industry
- Chemical industry

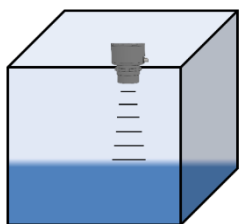

Measurement in rectangular tanks

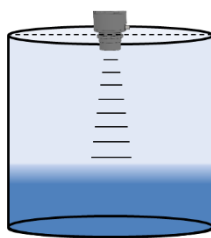

Measurement in cylinder tanks

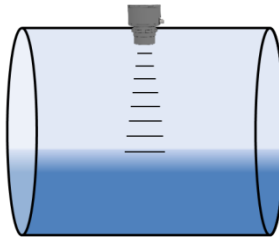

Measurement in horizontal cylinder tanks

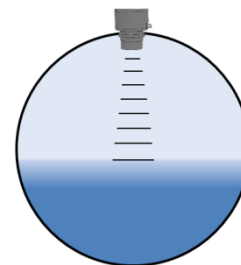

Measurement in cube tanks

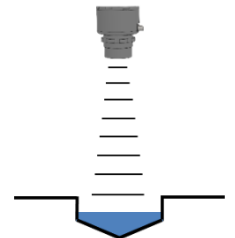

Measurement in flumes

TECHNICAL SPECIFICATIONS

Operating range	0.4 - 9 meters
Blind area	0.4 meters
Measurement Frequency	40 kHz
Accuracy	±%0.2 FS
Supply Voltage	16...30 VDC
Power consumption	2,4 Watt max.
Current consumption	100 mA max. @24 VDC / 150 mA max. @16 VDC
Sampling rate	4 Hz
Ultrasonic taper angle	30°
Minimum resolution	1 mm
Relay outputs (Optional)	2 x PNP Open Collector Outputs
Serial connection (Optional)	RS-232, RS-485, CANopen
Analog outputs (Optional)	0-10 V, 4-20 mA, 0-20 mA
Analog output load	500 Ω
Analog output resolution	16 Bit
Reverse connection protection	Yes
Overload protection	Yes (600 mA)
Temperature compensation	Yes
Watchdog	Yes
Electrical connection	M12 / 8 pin male and M12 / 5 pin female sockets (standard) 1 piece 8 x 0,14 mm ² shielded cable and 1 piece 5 x 0,14 mm ² shielded cable (optional)
Cable length	Standard 1 m, Optional others
Operating temperature	-40 °C ... 75 °C
Storage temperature	-40 °C ... 85 °C
Protection class	IP67
Weight	~700 gr
Housing material	Delrin® POM-C EN 10204

CANopen SPECIFICATIONS

Communication Profile	CiA 301
Cevaplama Frekansı	100 Hz.
Device Type	CANopen, CiA DS410
Node ID	Between 1 and 127, configurable via LSS or SDO.
Baud Rate	10 kBit/s, 20 kBit/s, 50 kBit/s, 100 kBit/s, 125 kBit/s, 250 kBit/s, 500 kBit/s, 800 kBit/s, 1 Mbit/s
PDO Data Rate	100 ms
Error Check	Heartbeat, Emergency Message
PDO	1 Tx PDO
PDO Modes	Event/Time triggered, Synch/Asynch
SDO	1 server
Position data	Object Dictionary 6004
Terminating Resistor	Optional

MECHANICAL DIMENSIONS (in mm)

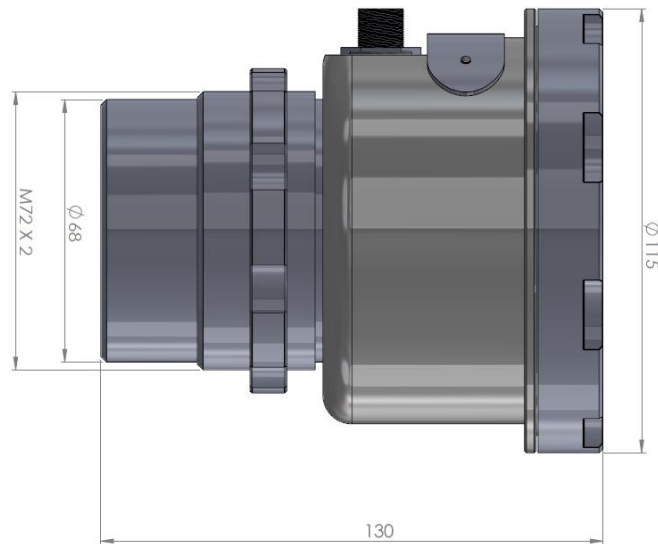

ELECTRICAL CONNECTIONS

CN1 (M12 / 8 Pin socket or cable)

Pin No	Signal	Cable Color
1	16...30VDC supply input	Red
2	GND – 0V	Black
3	Analog Out -	Green
4	Serial Communication (RS232 - Tx) (RS485 - B) (CAN - L)	Blue
5	Serial Communication (RS232 - Rx) (RS485 - A) (CAN - H)	White
6	Analog Out +	Yellow
7	Serial Communication GND	Grey
8	-	-

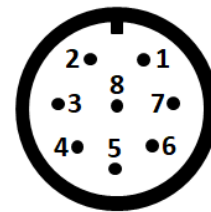

M12/8 Pin male socket
(front view of the socket on the sensor)



M12/8 Pin female socket
(front view of the cable-mounted socket)

CN2 (M12 / 5 Pin socket or cable)

Pin No	Signal	Cable Color
1	GND	Black
2	PNP Open Collector Output 1	Yellow
3	PNP Open Collector Output 2	Green
4	GND	Pink

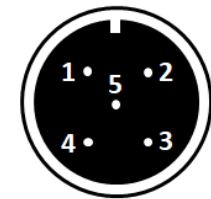

M12/5 Pin female socket
(front view of the socket on the sensor)

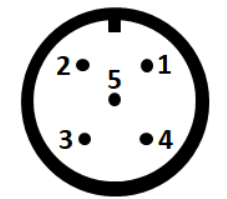

M12/5 Pin male socket
(front view of the cable-mounted socket)

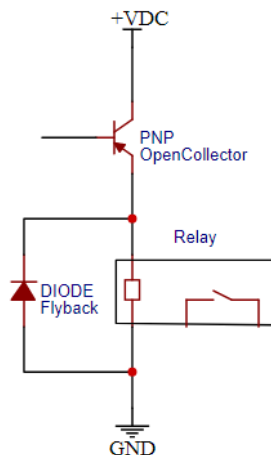

PNP Open Collector Output Schematic

MECHANICAL MOUNTING

Measurement Distance and ve Diameter

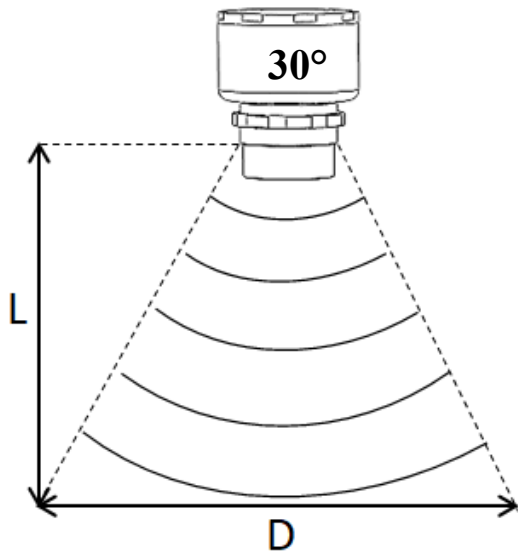

	OPTIMUM	MINIMUM
L	D	
1m	60 cm	100 cm
2m	120 cm	100 cm
3m	180 cm	100 cm
4m	240 cm	100 cm
5m	300 cm	120 cm
6m	360 cm	140 cm
7m	420 cm	160 cm
8m	480 cm	180 cm
9m	540 cm	200 cm

Mounting Warnings

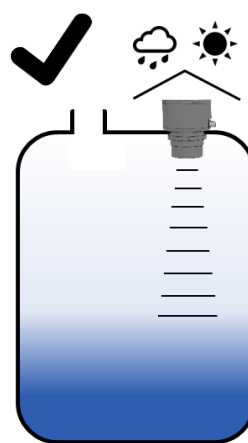
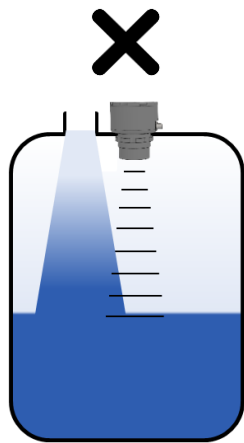

- For level measurement, the sensor must not be installed near the tank input.
- It is recommended that the sensor be protected against sun and rain.

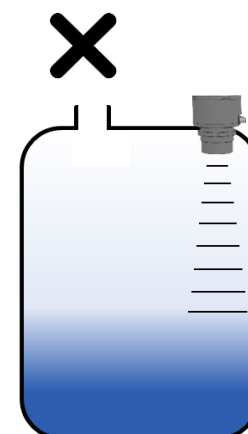
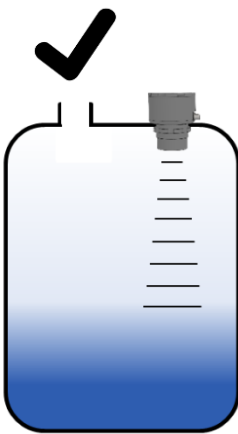

- The sensor must be installed perpendicular to the surface to be measured and should not be placed close to the side surface.

ORDER CODE

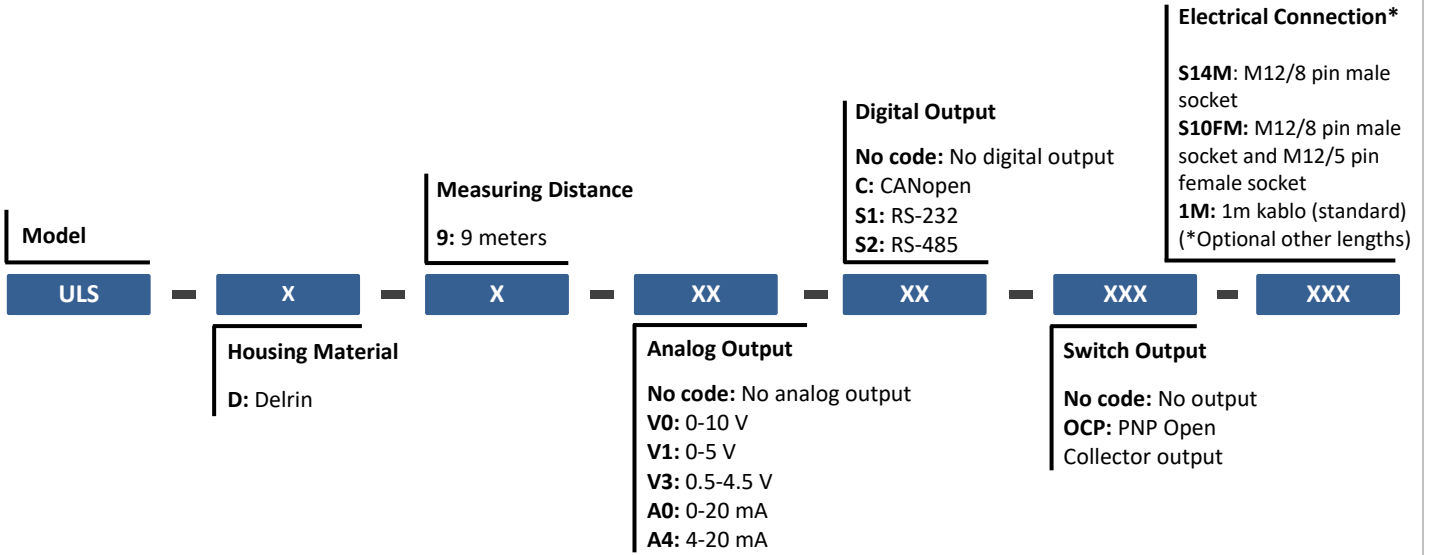

*S10FM coded socket should be selected if PNP Open Collector output is used, S14M coded socket should be selected if PNP Open Collector output or tare input is not used.

OPTIONAL PRODUCTS

Product	Code	Description
	S14F	M12/8 pin female socket (IP67) (For connection with M12/8 pin male socket on the sensor)
	S13M	M12/5 pin male socket (IP67) (For connection with M12/5 pin female socket on the sensor)
	CB8 XM / S14F	X meters 8x0,14 mm ² extension cable + M12/8 pin female socket (IP67) X = Max. 50 meters
	CB5 XM / S13M	X meters 5x0,14 mm ² extension cable + M12/5 pin male socket (IP67) X = Max. 50 meters

Atek Sensor Technologies



Tuzla KOSB Organize Sanayi Bölgesi Melek Aras Bulvarı, No:67 34956 Tuzla-İstanbul / TURKEY



Tel: +90 216 399 44 04



Fax: +90 216 399 44 02



www.ateksensor.com



info@ateksensor.com



Address / Endereço:

Rua Sete de Setembro, 2656
13560-181 - São Carlos - SP
Brazil / Brasil

Phone / Telefone:

+55 (16) 3371-0112
+55 (16) 3372-7800

Internet:

www.metrolog.net
metrolog@metrolog.net