

RT9DN

0–90° to 0–50 Turns • DeviceNET®

Industrial Grade Rotational Position Sensor
Absolute Rotary Position up to 50 turns
Aluminum or Stainless Steel Enclosure Options
IP68 / NEMA 6

GENERAL

Full Stroke Range Options	0-0.25 to 0-50 turns
Electrical Interface	CANbus ISO 11898
Protocol	DeviceNet Version 2.0
Accuracy	see ordering information
Repeatability	± 0.02% full stroke
Resolution	± 0.003% full stroke
Enclosure Material Options	powder-painted aluminum or stainless steel
Sensor	plastic-hybrid precision potentiometer
Potentiometer Cycle Life	see ordering information
Shaft Loading	up to 35 lbs. radial and 5 lbs. axial
Starting Torque (25°C)	2.0 in.-oz., max.
Weight, Aluminum (Stainless Steel) Enclosure	5 lbs. (10 lbs.) max.

ELECTRICAL

Input Voltage	Bus Powered
Input Current	40 mA max.
Address Setting (Node ID)	0...63 set via DIP Switches (default setting: 63)
Baud Rate	125K, 250K or 500K set via DIP Switches
EDS file	available @ http://celesco.com/downloads

ENVIRONMENTAL

Enclosure	NEMA 4/4X/6, IP 67/68
Operating Temperature	-40° to 200°F (-40° to 90°C)
Vibration	up to 10 g to 2000 Hz maximum

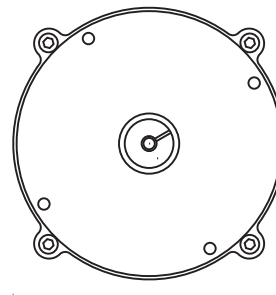

4.5" [114 mm]

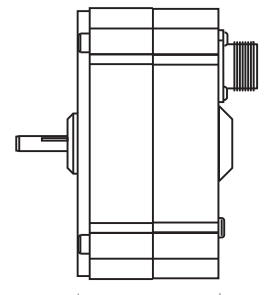

2.4" [59 mm]

Celesco's model RT9DN communicates rotational position feedback via DeviceNET® to your programmable controller. The heart of this sensor is a precision plastic-hybrid position potentiometer which provides a "absolute" position and does not ever have to be reset to a "home" position after a power loss or planned shutdown.

This innovative sensor from Celesco, designed to meet tough NEMA-4 and IP67 environmental standards, is available in full-stroke measurement ranges of 1/4 to 50 turns.

Output Signal:

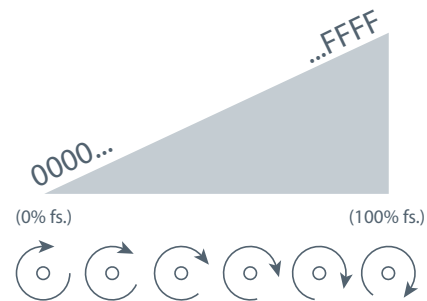

Outline Drawing:

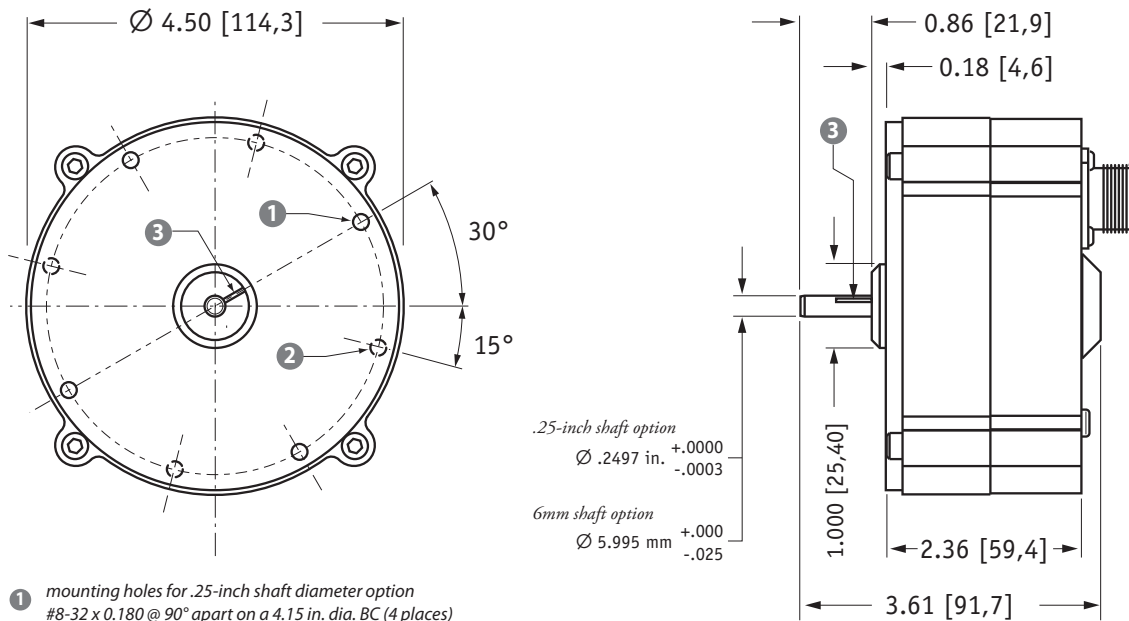

- 1 mounting holes for .25-inch shaft diameter option
#8-32 x 0.180 @ 90° apart on a 4.15 in. dia. BC (4 places)
- 2 mounting holes for 6-mm shaft diameter option
M4 x 4,5 mm @ 90° apart on a 105,4 mm dia. BC (4 places)
- 3 reference mark
full counter-clockwise position - align mark on shaft to mark on face for start of measurement range

DIMENSIONS ARE IN INCHES [MM]
 tolerances are ± 0.02 in. [$\pm 0,5$ mm] unless otherwise noted

Ordering Information:

Model Number:

RT9DN - _____
 order code: R A B C D E

Sample Model Number:

RT9DN - 30 - AL - 25 - 500 - TR - SC5

- R range: 30 turns
- A enclosure: powder-painted aluminum
- B shaft: .25-in diameter
- C baud rate: 500 k bits/sec.
- D terminating resistor: yes
- E electrical termination: 5-meter cordset with straight plug

Full Stroke Range:





R order code:	R25	R50	1	2	3	5	10	20	30	50
clockwise shaft rotations, min:	0.25	0.50	1	2	3	5	10	20	30	50
accuracy (% of f.s.):	0.3%	0.3%	0.3%	0.3%	0.3%	0.2%	0.15%	0.15%	0.15%	0.15%
potentiometer cycle life*:	2.5×10^6	2.5×10^6	2.5×10^6	2.5×10^6	2.5×10^6	5×10^5	2.5×10^5	2.5×10^5	2.5×10^5	2.5×10^5

*-number of times the sensor shaft can be cycled back and forth from beginning to end and back to the beginning before any measurable signal degradation may occur.

Enclosure Material:

A order code:	AL	SS
	powder-painted aluminum	303 stainless steel

Shaft Diameter:

B order code:	25	6	25F	6F
	0.25-in. diameter	6 mm diameter	0.25-in. dia. w/flats	6 mm dia. w/flats
				
	.2497 in. (+.0000 -0.0003)	5.995 mm (+.000 -0.025)	0.33 in. \leftarrow 0.025 in.	8.4 mm \leftarrow 0.64 mm

Ordering Information (cont.):

Baud Rate:

④ order code:	125	250	500
	125 kbaud	250 kbaud	500 kbaud

Terminating Resistor:

⑤ order code:	TR	NR
	terminating resistor	no terminating resistor

Electrical Connection:

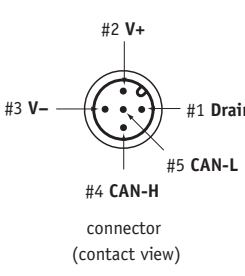
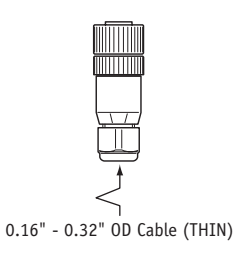
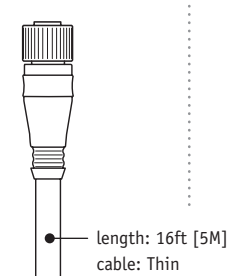
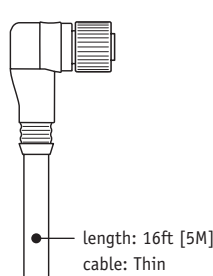
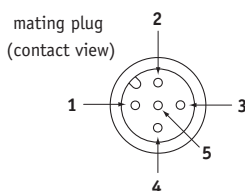
⑥ order code:	blank	MC5	SC5	NC5																		
	5-pin micro-connector <i>(no mating plug supplied)</i>	5-pin micro-connector w/ mating plug	5-pin micro-connector and 5 meter length cordset w/straight mating plug	5-pin micro-connector and 5 meter length cordset w/90° mating plug																		
	 <p>connector (contact view)</p>	 <p>0.16" - 0.32" OD Cable (THIN)</p>	 <p>length: 16ft [5M] cable: Thin</p>	 <p>length: 16ft [5M] cable: Thin</p>																		
		 <p>mating plug (contact view)</p>	<table border="1"> <thead> <tr> <th>pin</th> <th>signal</th> <th>wire color</th> </tr> </thead> <tbody> <tr> <td>1</td> <td>drain</td> <td>brown</td> </tr> <tr> <td>2</td> <td>V+</td> <td>white</td> </tr> <tr> <td>3</td> <td>V-</td> <td>blue</td> </tr> <tr> <td>4</td> <td>Can-H</td> <td>black</td> </tr> <tr> <td>5</td> <td>Can-L</td> <td>grey</td> </tr> </tbody> </table>	pin	signal	wire color	1	drain	brown	2	V+	white	3	V-	blue	4	Can-H	black	5	Can-L	grey	
pin	signal	wire color																				
1	drain	brown																				
2	V+	white																				
3	V-	blue																				
4	Can-H	black																				
5	Can-L	grey																				

I/O Format:

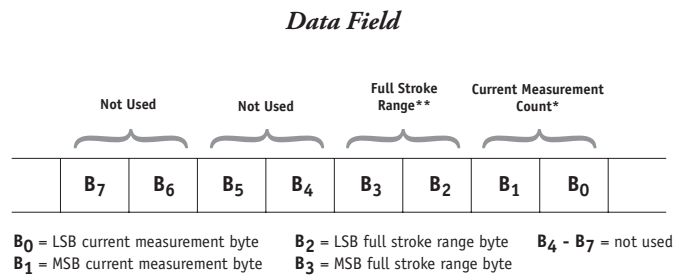
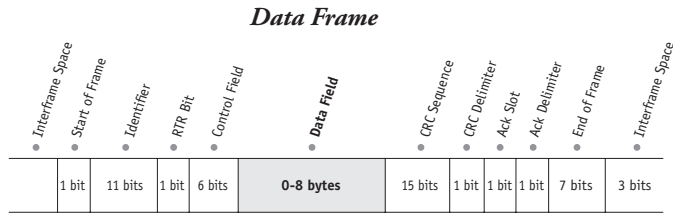

*Current Measurement Count

The **Current Measurement Count (CMC)** is the output data that indicates the present position of the measuring cable.

The CMC is a 16-bit value that occupies the first two bytes (B₀ and B₁) of the data field. B₀ is the LSB (least significant byte) and B₁ is the MSB (most significant byte).

The CMC starts at 0000H with shaft at the full counter-clockwise position (0° reference mark) and continues in the clockwise direction to the end of the stroke range stopping at FFFFH. This holds true for all ranges.

**Full Stroke Range

The **Full Stroke Range (FSR)** is a 16-bit value in the data field that expresses the full range of the sensor in degrees. This value can be used to convert the actual count to units of measurement should the application require it.

The full stroke measurement range occupies the second two bytes (B₂ and B₃) of the data field.

B₂ is the LSB (least significant byte) and B₃ is the MSB (most significant byte).

This value is expressed in degrees.

Example:

Hex Value	Decimal Equivalent	Full Stroke Range
0168	360	360 degrees

Converting CMC to Degrees

If required, the CMC can easily be converted to a rotational measurement expressed in degrees instead of counts.

This is accomplished by first dividing the CMC by 65,535 (total counts over the range) and then multiplying that value by the FSR:

$$\left(\frac{\text{CMC}}{65,535} \right) \times \text{FSR}$$

Example:

If the full stroke range is **1 turn (360 degrees)** and the current position is **OFF2 Hex (4082 Decimal)** then,

$$\left(\frac{4082}{65,535} \right) \times 360 \text{ deg.} = 22.4 \text{ degrees}$$

Address Setting (Node ID), Baud Rate and Bus Termination Settings

Address Setting (Node ID)

The Address Setting (Node ID) is set via 6 switches located on the 8-pole DIP switch found on the DeviceNET controller board located inside the transducer.

The DIP switch settings are binary starting with switch number 1 (= 2⁰) and ending with switch number 6 (= 2⁵).

DIP-1 (2 ⁰)	DIP-2 (2 ¹)	DIP-3 (2 ²)	DIP-4 (2 ³)	DIP-5 (2 ⁴)	DIP-6 (2 ⁵)	address (decimal)
0	0	0	0	0	0	0
1	0	0	0	0	0	1
0	1	0	0	0	0	2
...
1	1	1	1	1	1	63



Baud Rate

The transmission baud rate may be either factory preset at the time of order or set manually at the time of installation.

The baud rate can be set using switches 7 & 8 on the 8-pole DIP switch found on the DeviceNET controller board located inside the transducer.

DIP-7	DIP-8	baud rate
0	0	125k
1	0	250k
0	1	500k
1	1	125k



Bus Termination

The setting of the internal bus termination resistor may be specified upon order or manually changed by the end user at the time of installation.

The bus termination resistor is activated setting switches 1 & 2 on the 2-pole DIP switch (located on the internal DeviceNET controller board) to the "ON" position.

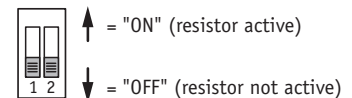

DeviceNET Controller Board and DIP Switch Location

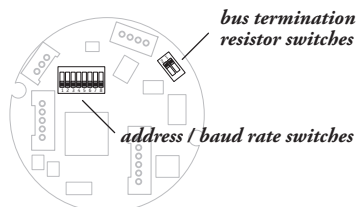

to gain access to the controller board, remove four Allen-Head Screws and separate case halves

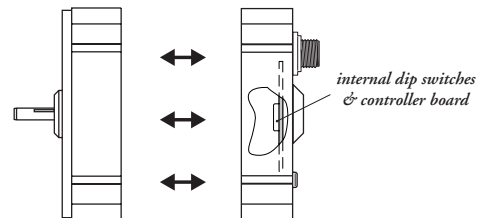

version: 2.0 last updated: March 1, 2014