

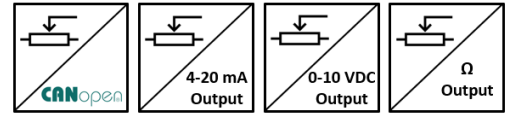

GENERAL FEATURES

- Different stroke (measuring) lengths between 0...2000 mm and 0...5100 mm
- $\pm 0.25\%$ FS linearity
- Potentiometric, 0-10 VDC, 4-20 mA analog output or CANopen output options
- Redundant output model option
- Stainless steel measuring wire
- IP65 protection class
- Compact design
- Easy installation
- 2 m/s maximum speed
- Shock/Vibration resistant
- Aluminum anodized body



AWP 810 series draw wire sensors; consists of a rotary potentiometer which is controlled by stainless steel wire. They make measurement by pulling and rewinding stainless steel wire. Different stroke (measuring) lengths between 0...2000 mm and 0...5100 mm are available. They convert linear motion to potentiometric output.

The “A” series gives of 4-20 mA analog output with the help of the converter card.
 The “V” series gives of 0-10 VDC analog output with the help of the converter card.
 The “C” series gives of CANopen signal output with the help of the converter card.

Optionally, redundant output, different non-standard measuring lengths, cable length or socket model can be requested.

TECHNICAL SPECIFICATIONS

*Stroke (measuring) Length	Different measuring lengths between 0...2000 mm and 0...5100 mm	Maximum Speed	2 m/s
		Required Force	12N
*Connection Cable Length	3m (standard), 5m, 10m	*Resistance	5 K Ω (standard), 10 K Ω
*Supply Voltage	“A” and “V” models: 12...30 VDC	Measuring Type	Potentiometric
	CANopen output model: 10...30 VDC		
*Output Signals	Potentiometric output model: 42V max.	Materials	Housing: Aluminum/steel /plastic
	Potentiometric 0-10 VDC 4-20 mA CANopen (Optionally Redundant Output)		Measuring Wire: Stainless steel
Linearity	$\pm 0.25\%$ FS	IP Protection Class	IP65
		Operating	-25°C ... +85°C
		Relative Humidity	%95
		Weight	≈ 2200 gr

Note: The technical specifications indicated by (*) vary according to the selected model. The detailed code table is shown on page 4.

CANopen SPECIFICATIONS

Resolution	23 Bit
Communication profile	CiA 301
Device Type	CANopen, CiA DS406
Node ID	Between 1 and 127, it can be adjusted with LSS or SDO
Baud Rate	10 kBit/s, 20 kBit/s, 50 kBit/s, 100 kBit/s, 125 kBit/s, 250 kBit/s, 500 kBit/s, 800 kBit/s, 1 Mbit/s
PDO Data Rate	500 ms
Error Control	Heartbeat, Emergency Message
PDO	2 Tx PDO
PDO Modes	Event/Time triggered, Synch/Asynch
SDO	1 server
Position Information	Object Dictionary 6004
Termination Resistance	Optional, specify at the order stage.

ELECTRICAL CONNECTION

Analog

0-10V or POTENTIOMETER Connection

Signal	Cable Color	M12 5 pin socket
Earth	Silver	Pin 1
+V	Red	Pin 2
0V	Black	Pin 3
0-10V / Pot	Yellow	Pin 4
-	-	Pin 5

4-20 mA Connection

Signal	Cable Color	M12 5 pin socket
Earth	Silver	Pin 1
+V	Red	Pin 2
-	-	Pin 3
4-20 mA	Yellow	Pin 4
-	-	Pin 5

* 1 pcs M12 5 pin male connector is used as standard for single output models

* Redundant models have two outputs. 1 pcs M12 5 pin male and 1 pcs M12 5 pin female sockets are used as standard.

* Different socket models can be requested optionally.

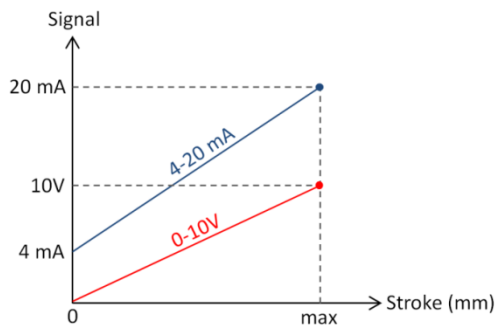

CANopen

Signal	Cable Color	M12-5 Pin Socket
CAN_SHIELD	Silver (mesh)	Pin 1
+V (10...30 VDC)	Red	Pin 2
GND (0V)	Black	Pin 3
CAN_H	Yellow	Pin 4
CAN_L	Green	Pin 5

* CANopen models have 2 outputs. 1 pcs M12 5 pin male and 1 pcs M12 5 pin female sockets are used as standard.

* Different socket models can be requested optionally.

M12 5 Pin Female Soket

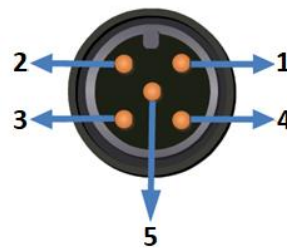

M12 5 Pin Male Soket

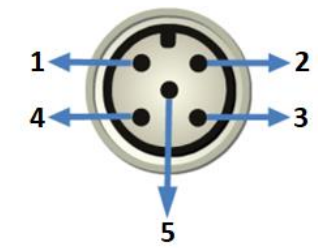

MECHANICAL DIMENSIONS (mm)

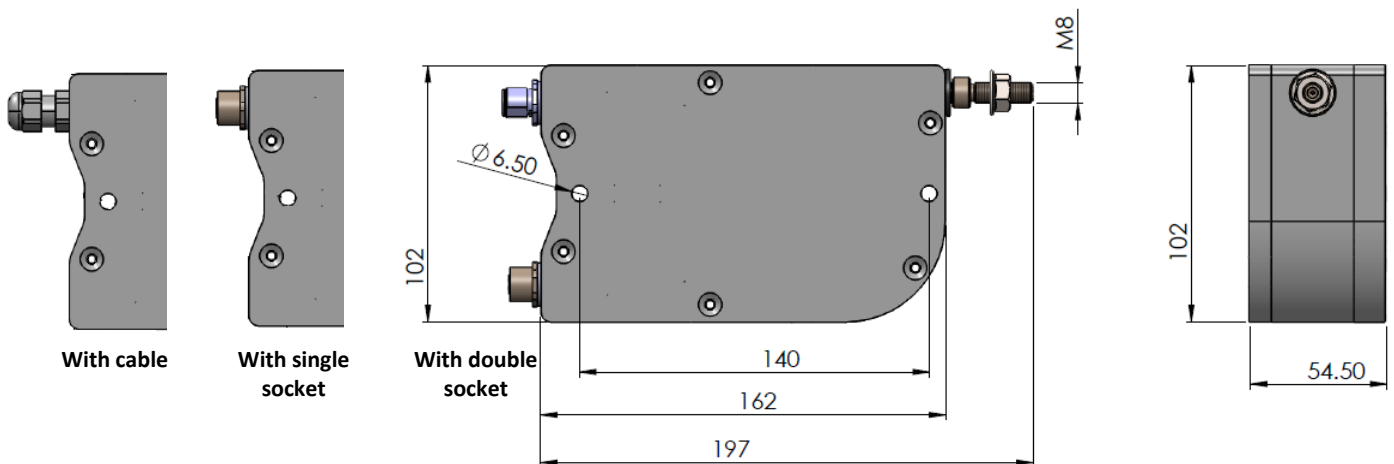

MOUNTING AND WARNINGS

1. Never release the wire after pulling. Otherwise, the coil spring will be damaged.

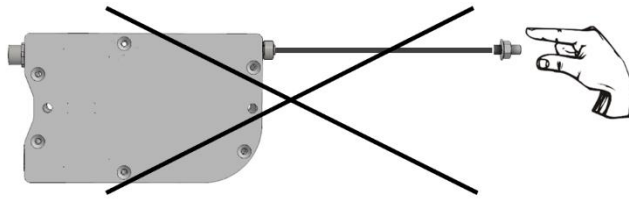

2. Mount the sensor according to the mounting directions shown below.

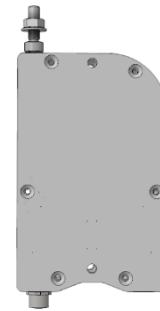
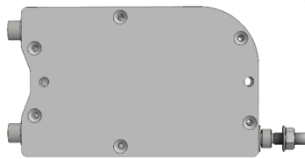
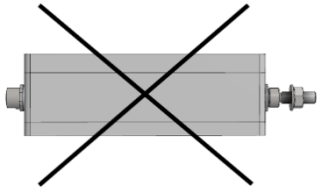

3. If there is a trickle of water (like a rain), the wire outlet must not be a drip of water upstream. If needed please use guide rollers.

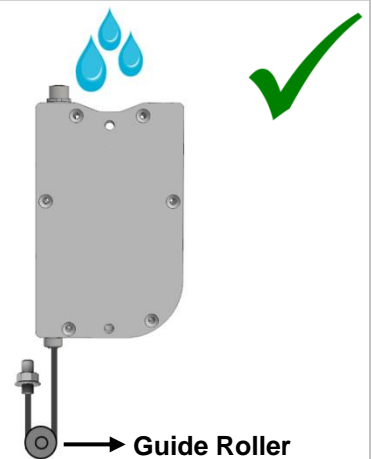
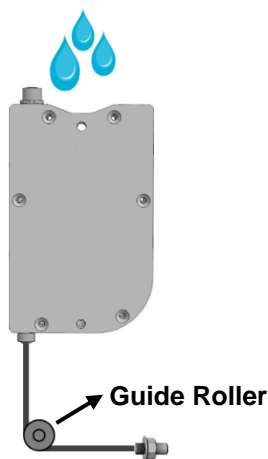
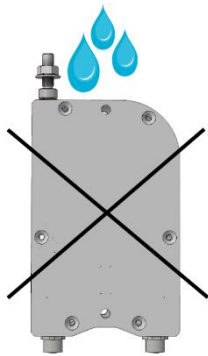

4. The wire should not be pulled in angular. If needed, please use guide rollers.

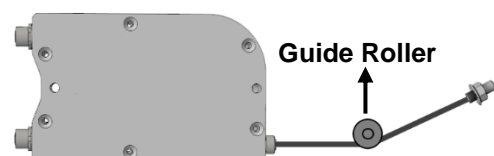
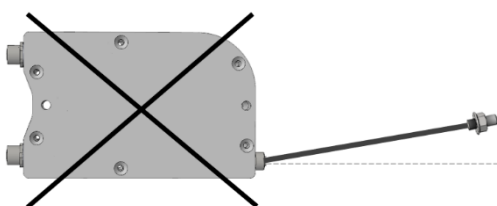

Important Note(!): Failure to comply with these recommendations, the malfunctions that may occur will not be under the warranty.

SAMPLE APPLICATION FIELDS

- Elevators
- Press machines
- Crane systems
- Wood processing machines
- Marble processing machines
- Storage positioning
- Dam protections
- Sluice gate control
- Air compressors
- Glass processing machines
- Lifting platforms
- Applications in medical technologies (operating table etc.)
- Forklifts
- Screw machines
- Paper machines
- Sewing machines
- Hydraulic machines
- Sheet metal machines
- Printing machines
- Horizontal control equipments
- Construction machines
- Industrial robots
- Injection machines
- X-Y axis displacement
- Liquid level measurements and position control

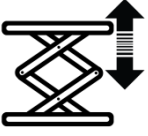

PRODUCT CODE

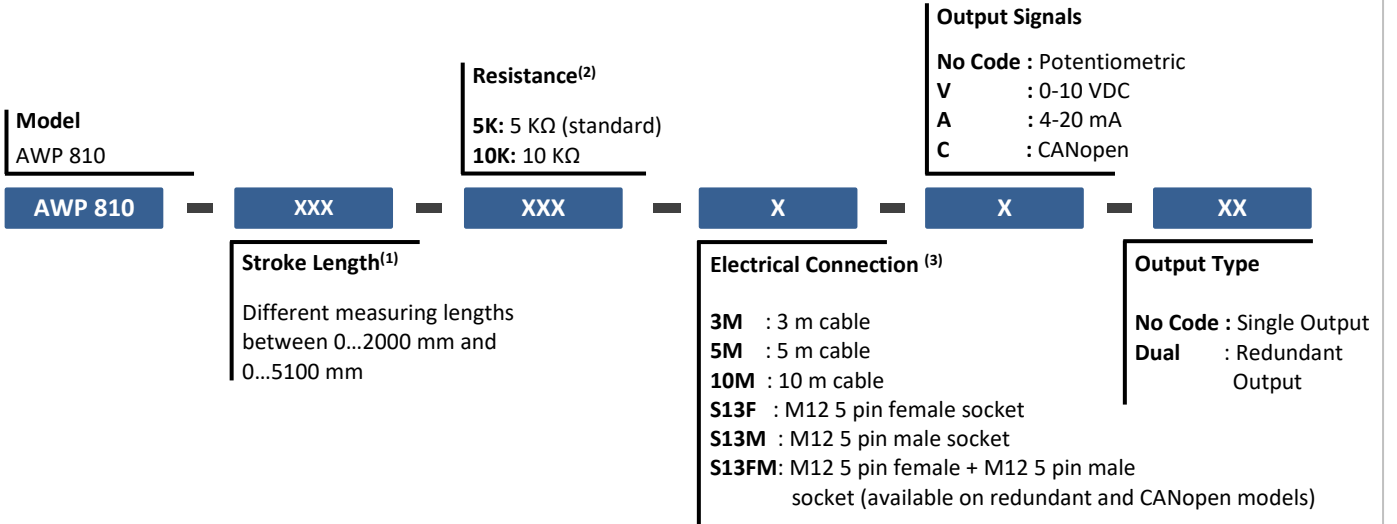

(1) For other (special production) stroke lengths, please contact us.

(2) For other resistance options, please contact us.

(3) The product can be requested with cable or socket.

As standard;

For single output models, 1 pcs M12 5 pin male socket (S13M) is used.

For redundant and CANopen output models, 1 pcs M12 5 pin female + 1 pcs M12 5 pin male socket (S13FM) is used.

However, different socket combinations may be requested as in the examples below.

Please contact us for any other socket model other than M12.

Sample 1: AWP-810-3000-5K-S13M-A-DUAL

AWP 810 series, 3000 mm stroke, 5K resistance, **2 pcs M12 5 pin male socket**, current output, redundant

Sample 2: AWP-810-3000-5K-S13FM-C-DUAL

AWP 810 series, 3000 mm stroke, 5K resistance, **1 pcs M12 5 pin female + 1 pcs M12 5 pin male socket**, CAN output, redundant

Sample 3: AWP-810-3000-5K-3M-A-DUAL

AWP 810 series, 3000 mm stroke, 5K resistance, **3 meters cable output**, current output, redundant

Atek Elektronik Sensör Teknolojileri Sanayi ve Ticaret A.Ş.



Gebze OSB, 800. Sokak, No:814 Gebze/KOCAELI/TURKEY



Tel: +90 262 673 76 00



Tel: +90 262 673 76 08



www.ateksensor.com



info@ateksensor.com



Address / Endereço:

Rua Sete de Setembro, 2656
13560-181 - São Carlos - SP
Brazil / Brasil

Phone / Telefone:

+55 (16) 3371-0112
+55 (16) 3372-7800

Internet:

www.metrolog.net
metrolog@metrolog.net