

GENERAL INFORMATION

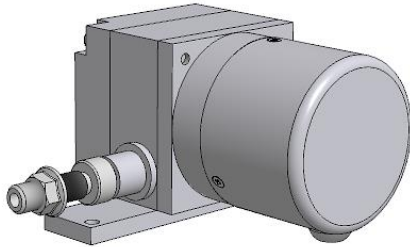

AWP 110 series draw wire sensors; consists of a rotary potentiometer which is controlled by stainless steel wire. They make measurement by pulling and rewinding stainless steel wire.

Different measuring lengths from 100 mm to 1200 mm are available. They convert linear motion to potentiometric output.

The "A" series, works with 24VDC supply and gives of 4-20 mA analog output with the help of the converter card.

The "V" series, works with 24VDC supply and gives of 0-10 VDC analog output with the help of the converter card.

Optionally, different non-standard measuring lengths, cable length or socket model can be requested.

WARNINGS

- The installation of the product is carried out by the customer who purchases the product, according to the wiring diagrams, installation information, etc. in this manual.
- Maintenance and repair should be done by the technicians authorized by the manufacturer firm.
- There must be minimum distance between the sensor and control unit. Avoid additions except the suitable connector unless it needs.
- Keep away the sensor cable from as high power energy cables, contactor, motor, switched power supplies, inductive and capacitive noisy supplies.
- Shielding edge of the sensor cable must be ground connected.
- Not to damage the sensor, supply directions and voltage must be paid attention. Don't energize before all connections completed.
- Transport and storage should be at their original packaging and an ambient temperature of -25°C / + 85°C in such a way that they will not be exposed to dust, humidity, impact, vibration, falling or water.
- Chemicals such as alcohol, thinner etc. should not be used for cleaning the product. The product should be wiped with a damp cloth.
- The product may be damaged and may become unusable if used outside of the specifications in the user manual.
- The product will be out of warranty if used outside of the specifications in the user manual and opened or repaired other than authorized services.

ELECTRICAL CONNECTIONS

Never make or undo electrical connections to the sensor when voltage is applied, otherwise this may result in damage to devices.

| 4-20 mA Connection | | |
|--------------------|-------------|-----------------------|
| Signal | Cable Color | M12 5 pin male socket |
| Earth | Silver | Pin 1 |
| +V | Red | Pin 2 |
| - | - | Pin 3 |
| 4-20 mA | Yellow | Pin 4 |
| - | - | Pin 5 |

M12 5 Pin Male Socket

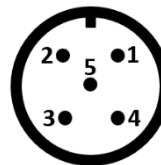

| 0-10V or POTENTIOMETER Connection | | |
|-----------------------------------|-------------|-----------------------|
| Signal | Cable Color | M12 5 pin male socket |
| Earth | Silver | Pin 1 |
| +V | Red | Pin 2 |
| 0V | Black | Pin 3 |
| 0-10V / Pot | Yellow | Pin 4 |
| - | - | Pin 5 |

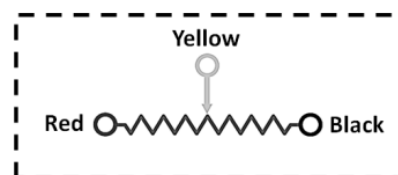

MECHANICAL MOUNTING

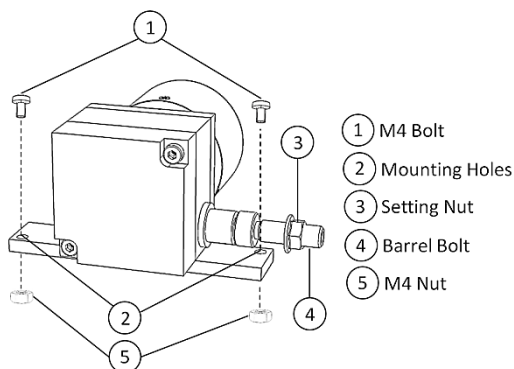

1- The product should be mounted to the relevant area with 2 units M4 bolts(1) and nuts(5) from the mounting holes (2) according to the mounting directions shown on page 3.

2- The sensor wire should be pulled towards the position to be connected with the barrel bolt (4).

3- The sensor wire should be mounted on the device to be connected by using the setting nut (3).

DIMENSIONS

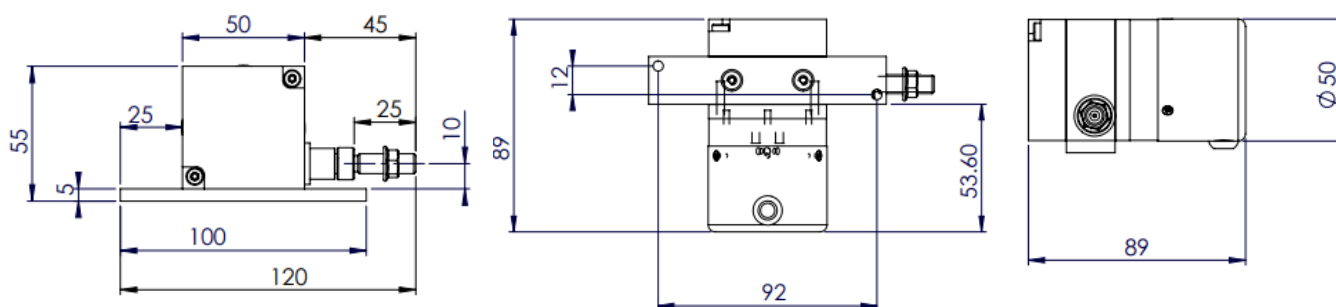

TECHNICAL SPECIFICATIONS

| | | | |
|-----------------------------------|--|---------------------------------|--|
| *Stroke (measuring) length | Different measuring lengths from 100 mm to 1200 mm | Required Force | 5 N |
| Linearity | ±0.25% FS | Operating Temperature | -25°C ... +85°C |
| *Supply Voltage | 'A' and 'V' models: 12...30 VDC | Relative Humidity | %95 |
| | Potentiometric output model: 42V max. | Materials | Housing: Aluminum/steel / plastic Measuring Wire: Stainless steel |
| *Signal Output Type | Potentiometric 0-10 VDC 4-20 mA | *Connection cable length | 3m (standard), 5m, 10m |
| Measuring Type | Potentiometric | IP Protection Class | IP53 |
| *Resistance | 5 KΩ (standard), 10 KΩ | Weight | ≈550 gr |
| Maximum Speed | 2 m/s | | |

Note: The technical specifications indicated by (*) vary according to the selected model. The detailed code table is shown on page 4.

MOUNTING AND USAGE WARNINGS

1. Never release the wire after pulling. Otherwise, the coil spring will be damaged.

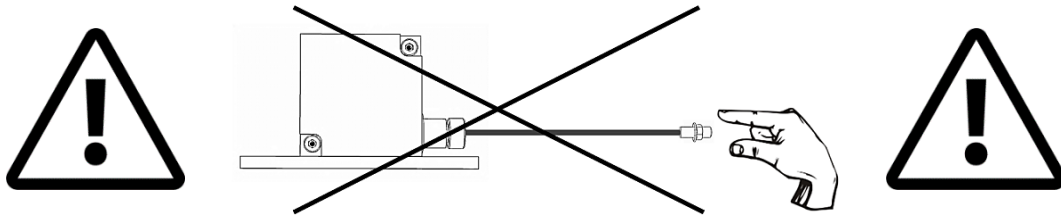

2. The wire sensor must be mounted vertically in position, not be horizontally.

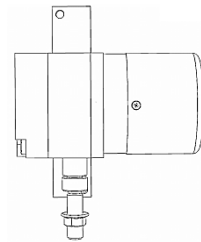
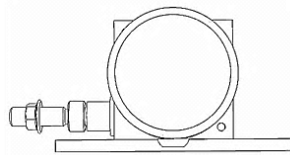
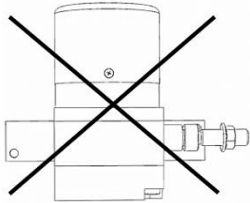

3. If there is a trickle of water (like a rain), the wire outlet must not be a drip of water upstream. If needed please use guide rollers.

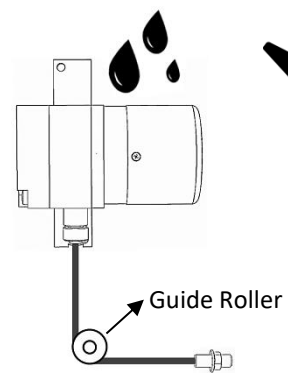
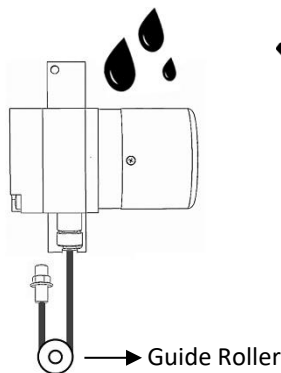
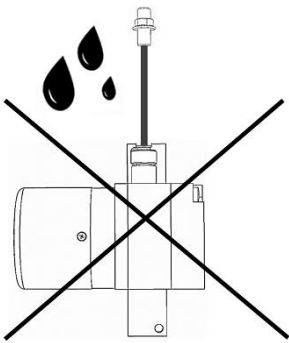

4. The wire should not be pulled in angular. If needed, please use guide rollers.

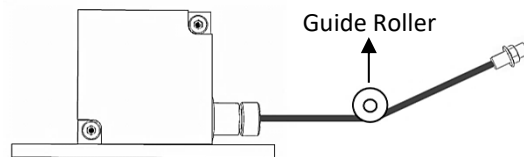
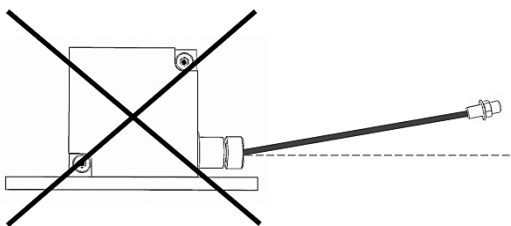

Important Note(!): Failure to comply with these recommendations, the malfunctions that may occur will not be under the warranty.

BOX CONTENTS

| Product | Description |
|---------------------------|--------------------------|
| AWP 110 | Draw Wire Sensor |
| Mounting Equipment | 2 pcs. M4 bolts and nuts |
| User Manual | 1 pcs. |

PRODUCT CODE TABLE

| | | | | |
|--|------------|---|----------|--|
| Model AWP 110 | | Resistance ⁽²⁾ 5K: 5 K Ω (standard) 10K: 10 K Ω | | Output Signals No Code : Potentiometric V : 0-10 VDC A : 4-20 mA |
| AWP 110 | XXX | XX | X | XX |
| Stroke Length ⁽¹⁾ Different measuring lengths from 100 mm to 1200 mm | | Electrical Connection⁽³⁾ 3M : 3 m 5M : 5 m 10M : 10 m S13 : M12 5 pin male socket | | |

- (1) For other (special production) stroke lengths, please contact us.
 (2) For other resistance options, please contact us.
 (3) Please contact us for other cable length and socket model requests.

Sample Code 1: AWP-110-300-5K-S13-A

Explanation: AWP 110 series, 300 mm stroke, 5K resistance, 1 pcs M12 5 pin male socket, current output



Manufacturer Firm's Title, Address Details

Manufacturer Firm: ATEK ELEKTRONİK SENSÖR TEKNOLOJİLERİ SANAYİ VE TİCARET A.Ş.

Address: Gebze OSB, 800. Sokak, No:814 Gebze/KOCAELİ/TURKEY

TEL: +90 262 673 76 00 **FAX:** +90 262 673 76 08

Web: www.ateksensor.com **E-mail:** info@ateksensor.com

Authorized Service's Title, Address Details

Authorized Service: ATEK ELEKTRONİK SENSÖR TEKNOLOJİLERİ SANAYİ VE TİCARET A.Ş.

Address: Gebze OSB, 800. Sokak, No:814, Gebze/KOCAELİ/TURKEY

TEL: +90 262 673 76 00 **FAX:** +90 262 673 76 08

Web: www.ateksensor.com **E-mail:** info@ateksensor.com



Disposal of Packagings: Packaging materials consist of recyclable materials. For providing recycling, please dispose waste packagings to collecting points of authorized recycling facilities.

Disposal of E-Waste: This device is in conformity with WEEE Directive and consists of recyclable materials. This product should not be disposed with general waste for preventing negative effects on environment and human health. This product should be disposed to collecting points of authorized recycling facilities. Further information can be reached from authorized unit.



Address / Endereço:

Rua Sete de Setembro, 2656
13560-181 - São Carlos - SP
Brazil / Brasil

Phone / Telefone:

+55 (16) 3371-0112
+55 (16) 3372-7800

Internet:

www.metrolog.net
metrolog@metrolog.net